

SHARP

MINI COMPONENT SYSTEM

MODEL

CD-MPS660E

OPERATION MANUAL

COMPACT
disc
DIGITAL AUDIO

MP3

Thank you for purchasing this SHARP product.
To obtain the best performance from this product, please read this manual carefully. It will guide you in operating your SHARP product.

CD-MPS660E Mini Component System consisting of CD-MPS660E (main unit) and CP-MPS660E (speaker system).

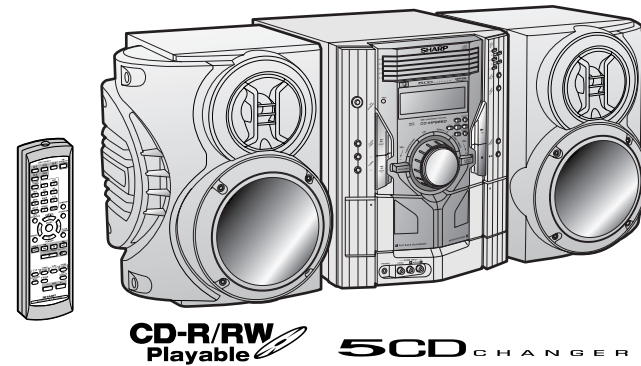

Accessories

Please confirm that the following accessories are included.

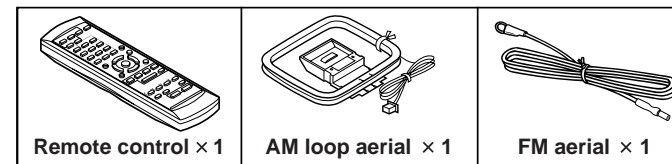

Note:

Only the above accessories are included.

Special notes

Warning:

- When the ON/STAND-BY button is set at STAND-BY position, mains voltage is still present inside the unit. When the ON/STAND-BY button is set at STAND-BY position, the unit may be brought into operation by the timer mode or remote control.
- This unit contains no user serviceable parts. Never remove covers unless qualified to do so. This unit contains dangerous voltages, always remove mains plug from the socket before any service operation and when not in use for a long period.
- To prevent fire or shock hazard, do not expose this appliance to dripping or splashing. No objects filled with liquids, such as vases, should be placed on the apparatus.

Note for users in Australia:

Copyright may exist in material you wish to record. Copying or broadcasting such material without permission of the relevant licensees or owners of the copyright is prohibited by law. SHARP is not in a position to authorise the copying or broadcasting of copyright materials and nothing in this OPERATION MANUAL should be implied as giving that authority.

For other countries:

Audio-visual material may consist of copyrighted works which must not be recorded without the authority of the owner of the copyright. Please refer to the relevant laws in your country.

CAUTION

- This product is classified as a CLASS 1 LASER product.
- This product contains a low power laser device. To ensure continued safety do not remove any cover or attempt to gain access to the inside of the product. Refer all servicing to qualified personnel.

Contents

	Page
■ General Information	
Precautions	3
Controls and indicators	4 - 7
■ Preparation for Use	
System connections	8 - 10
Remote control	11
■ Basic Operation	
General control	12
Setting the clock	13
■ CD or MP3 disc Playback	
Listening to a CD or MP3 disc	14 - 16
Advanced CD or MP3 disc playback	17 - 19
MP3 navigation (only for MP3 files)	20 - 23
■ Radio	
Listening to the radio	24, 25
■ Tape Playback	
Listening to a cassette tape (TAPE 1 or TAPE 2)	26, 27
■ Tape Recording	
Recording on a cassette tape	27 - 29
■ Advanced Features	
Timer and sleep operation	30 - 33
Enhancing your system	34, 35
■ References	
Troubleshooting chart	35 - 37
Maintenance	37
Specifications	38
WARRANTY	End of the manual

Precautions

CD-MPS660E

1

■ General

- Please ensure that the equipment is positioned in a well ventilated area and ensure that there is at least 10 cm (4") of free space along the sides, top and back of the equipment.

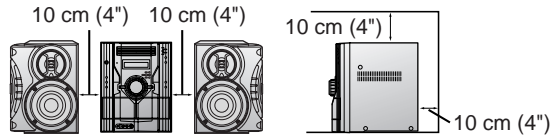

- Use the unit on a firm, level surface free from vibration.

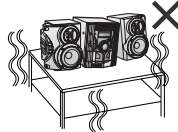

- Keep the unit away from direct sunlight, strong magnetic fields, excessive dust, humidity and electronic/electrical equipment (home computers, facsimiles, etc.) which generate electrical noise.
- Do not place anything on top of the unit.
- Do not expose the unit to moisture, to temperatures higher than 60°C (140°F) or to extremely low temperatures.
- If your system does not work properly, disconnect the AC power lead from the wall socket. Plug the AC power lead back in, and then turn on your system.
- In case of an electrical storm, unplug the unit for safety.

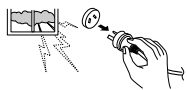
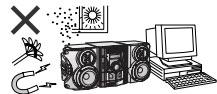

- Hold the AC power plug by the head when removing it from the wall socket, as pulling the lead can damage internal wires.



- Do not remove the outer cover, as this may result in electric shock. Refer internal service to your local SHARP service facility.

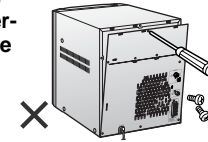

- The ventilation should not be impeded by covering the ventilation openings with items, such as newspapers, tablecloths, curtains, etc.

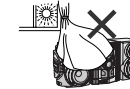

- No naked flame sources, such as lighted candles, should be placed on the apparatus.
- Attention should be drawn to the environmental aspects of battery disposal.
- This unit should only be used within the range of 5°C - 35°C (41°F - 95°F).

Warning:

The voltage used must be the same as that specified on this unit. Using this product with a higher voltage other than that which is specified is dangerous and may result in a fire or other type of accident causing damage. SHARP will not be held responsible for any damage resulting from use of this unit with a voltage other than that which is specified.

■ Volume control

The sound level at a given volume setting depends on speaker efficiency, location, and various other factors. It is advisable to avoid exposure to high volume levels. Do not turn the volume on to full at switch on and listen to music at moderate levels.

General Information

3

Controls and indicators

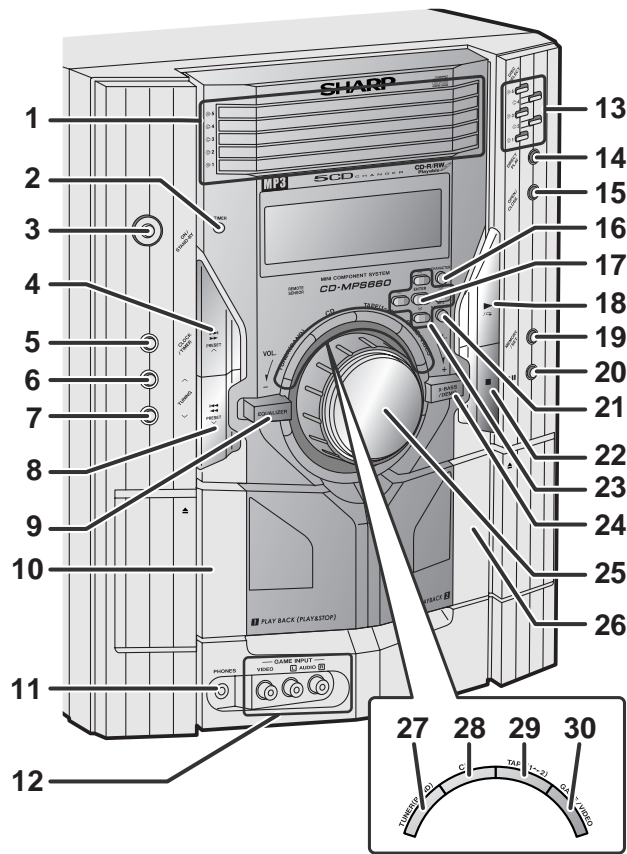

■ Front panel

	Reference page
1. Disc Trays	15
2. Timer Indicator	31
3. On/Stand-by Button	12
4. Disc Track Up or Fast Forward, Tape 2 Fast Forward, Tuner Preset Up, Time Up Button	13, 16, 25, 27
5. Clock/Timer Button	13, 30, 33
6. Tuning Up Button	24
7. Tuning Down Button	24
8. Disc Track Down or Fast Reverse, Tape 2 Rewind, Tuner Preset Down, Time Down Button	13, 16, 25, 27
9. Equaliser Mode Select Button	12
10. Tape 1 Cassette Compartment	26
11. Headphone Socket	35
12. Game/Video Input Sockets	34
13. Disc Number Select Buttons	15
14. Disc Direct Play Button	17
15. Disc Tray Open/Close Button	15
16. Character Button	22
17. Enter Button	21
18. Disc Play or Repeat, Tape Play Button	15, 18, 26
19. Memory/Set Button	13, 19, 23, 25, 30, 33
20. Tape 2 Record Pause Button	28, 29
21. MP3 Disc Navigation Mode Select Button	21
22. Disc or Tape Stop Button	16, 27
23. Cursor Buttons	21
24. Extra Bass/Demo Mode Button	10, 12
25. Volume Control	12
26. Tape 2 Cassette Compartment	26
27. Tuner (Band) Button	24
28. CD Button	15
29. Tape (1 → 2) Button	26
30. Game/Video Button	34

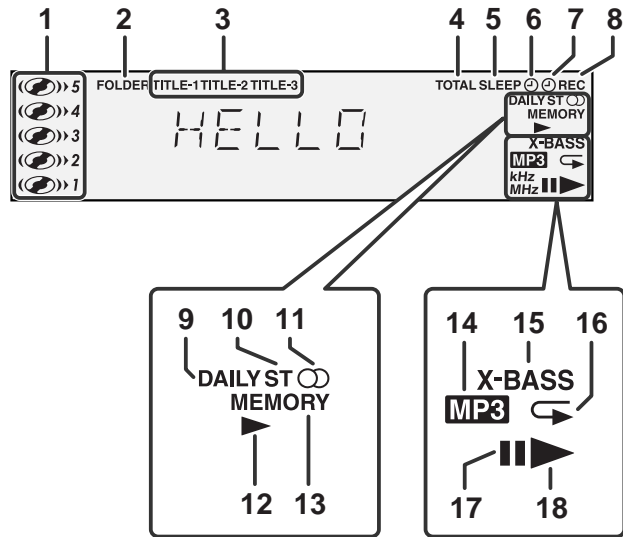

■ Display

	Reference page
1. Disc Number Indicators	17
2. MP3 Folder Indicator	20
3. MP3 Title Indicators	20
4. MP3 Total Indicator	21
5. Sleep Indicator	33
6. Timer Play Indicator	31
7. Timer Recording Indicator	31
8. Tape 2 Record Indicator	28
9. Daily Timer Indicator	31
10. FM Stereo Mode Indicator	24
11. FM Stereo Receiving Indicator	24
12. Tape Play Indicator	26
13. Memory Indicator	19, 23
14. MP3 Disc Indicator	15
15. Extra Bass Indicator	12
16. Disc Repeat Play Indicator	18
17. Disc Pause Indicator	16
18. Disc Play Indicator	15

Controls and indicators (continued)

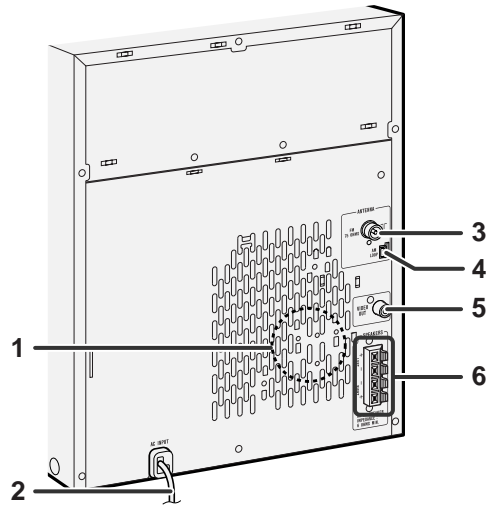

■ Rear panel

	Reference page
1. Cooling Fan	10
2. AC Power Lead	10
3. FM 75 Ohms Aerial Socket	9
4. AM Loop Aerial Socket	9
5. Video Output Socket	34
6. Speaker Terminals	9

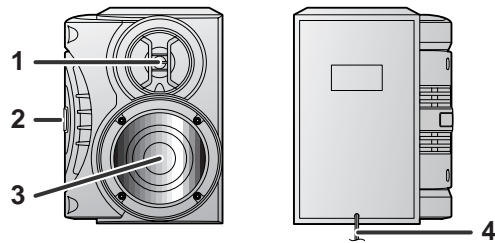

■ Speaker system

- 1. Tweeter
- 2. Passive Radiator
- 3. Woofer
- 4. Speaker Wire

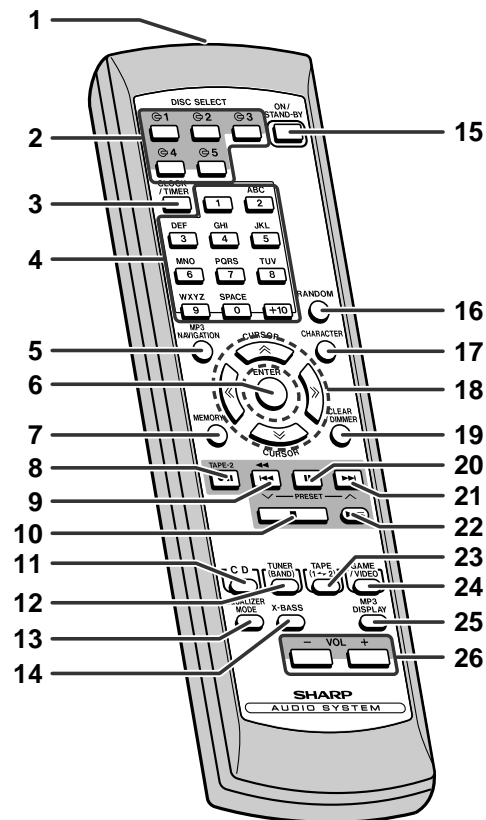

■ Remote control

	Reference page
1. Remote Control Transmitter	11
2. Disc Number Select Buttons	15
3. Clock/Timer Button	13, 30, 33
4. Character Input/Disc Direct Search Buttons	17, 22
5. MP3 Disc Navigation Mode Select Button	21
6. Enter Button	21
7. Memory/Set Button	13, 19, 23, 25, 30, 33
8. Tape 2 Record Pause Button	28, 29
9. Disc Track Down or Fast Reverse, Tape 2 Rewind, Tuner Preset Down, Time Down Button	13, 16, 25, 27
10. Disc or Tape Stop Button	16, 27
11. CD Button	15
12. Tuner (Band) Button	24
13. Equaliser Mode Select Button	12
14. Extra Bass Button	12
15. On/Stand-by Button	12
16. Disc Random Button	18
17. Character Button	22
18. Cursor Buttons	21
19. Disc Clear/Dimmer Button	12, 19
20. Disc Pause Button	16
21. Disc Track Up or Fast Forward, Tape 2 Fast Forward, Tuner Preset Up, Time Up Button	13, 16, 25, 27
22. Disc Play or Repeat, Tape Play Button	15, 18, 26
23. Tape (1 - 2) Button	26
24. Game/Video Button	34
25. MP3 Disc Display Button	16
26. Volume Up and Down Buttons	12

System connections

Preparation for Use

Make sure to unplug the AC power lead before any connections.

■ Aerial connection (see page 9)

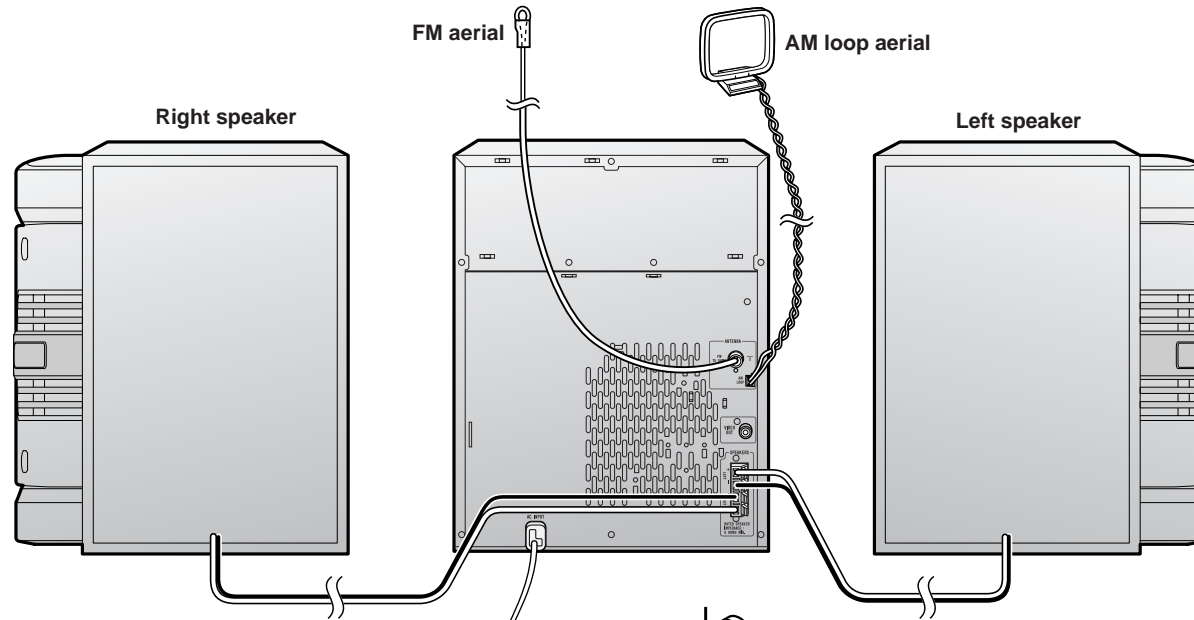

■ Speaker connection (see page 9)

Wall socket
(AC 230 - 240 V, 50 Hz)

■ AC power connection (see page 10)

■ Aerial connection

Supplied FM aerial:

Connect the FM aerial wire to the FM 75 OHMS socket and position the FM aerial wire in the direction where the strongest signal can be received.

Supplied AM loop aerial:

Connect the AM loop aerial to the AM LOOP socket. Position the AM loop aerial for optimum reception. Place the AM loop aerial on a shelf, etc., or attach it to a stand or a wall with screws (not supplied).

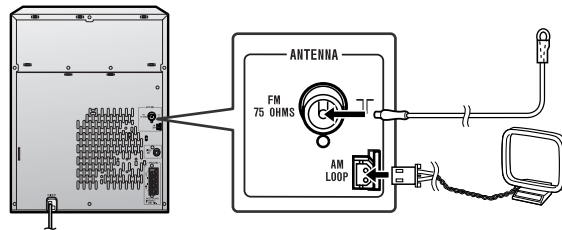

Note:

Placing the aerial on the unit or near the AC power lead may cause noise pickup. Place the aerial away from the unit for better reception.

Installing the AM loop aerial:

< Assembling >

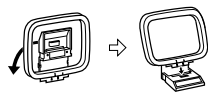

< Attaching to the wall >

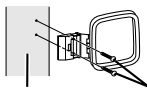

Wall Screws (not supplied)

■ Speaker connection

Connect the black wire to the minus (-) terminal, and the red wire to the plus (+) terminal.

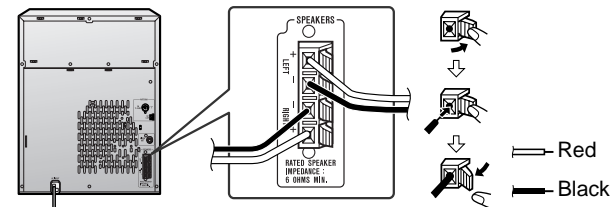

Caution:

- Use speakers with an impedance of 6 ohms or more, as lower impedance speakers can damage the unit.
- Do not mistake the right and the left channels. The right speaker is the one on the right side when you face the unit.
- **Do not let the bare speaker wires touch each other.**
- Do not stand or sit on the speakers. You may be injured.

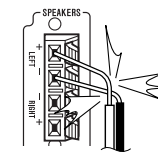

Incorrect

■ Placing the speaker system

The left and right speakers have individual shapes. For best performance, place the speakers according to the diagram below.

Left speaker

Right speaker

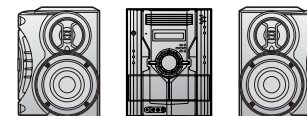

Note:

The speaker grilles are not removable.

System connections (continued)

■ AC power connection

After checking all the connections have been made correctly, plug the AC power lead of this unit into the wall socket. If you plug in the unit first, the unit will enter the demonstration mode.

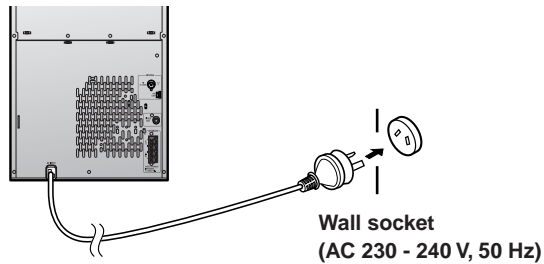

Notes:

- The unit will start the tape initialisation when plugged in to the AC socket. During this process, initialising sound will be heard and the unit cannot be turned on. Wait until the process is finished.
- Unplug the AC power lead from the wall socket if the unit will not be in use for a prolonged period of time.

Cooling fan:

This product is equipped with a cooling fan inside, which begins to run at a specified volume level for better heat radiation.

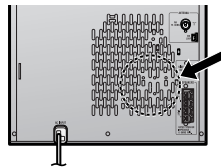

■ Demonstration mode

The first time the unit is plugged in, the unit will enter the demonstration mode. You will see words scroll.

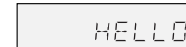

To cancel the demonstration mode:

When the unit is in the power stand-by mode (demonstration mode), press the X-BASS/DEMO button. The demonstration mode will be cancelled and the display will disappear.



To return to the demonstration mode:

When the unit is in the power stand-by mode, press the X-BASS/DEMO button again.

Note:

When the power is on, the X-BASS/DEMO button can be used to select the extra bass mode.

■ External FM aerial

Use an external FM aerial if you require better reception. Consult your dealer.

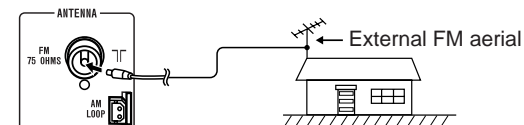

Remote control

CD-MPS660E

■ Battery installation

Use 2 "AA" size batteries (UM/SUM-3, R6, HP-7 or similar).
Batteries are not included.

- 1 **Open the battery cover.**
- 2 **Insert the batteries according to the direction indicated in the battery compartment.**
When inserting or removing the batteries, push them towards the ⊖ battery terminals.
- 3 **Close the battery cover.**

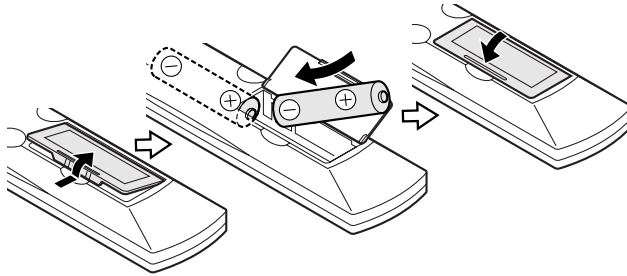

Precautions for battery use:

- Replace all old batteries with new ones at the same time.
- Do not mix old and new batteries.
- Remove the batteries if the unit is not to be used for long periods of time. This will prevent potential damage due to battery leakage.

Caution:

- Do not use rechargeable batteries (nickel-cadmium battery, etc.).
- Installing the batteries incorrectly may cause the unit to malfunction.

Notes concerning use:

- Replace the batteries if the operating distance is reduced or if the operation becomes erratic.
- Periodically clean the transmitter on the remote control and the sensor on the unit with a soft cloth.
- Exposing the sensor on the unit to strong light may interfere with operation. Change the lighting or the direction of the unit.
- Keep the remote control away from moisture, heat, shock, and vibrations.

■ Test of the remote control

Check the remote control after checking all the connections (see pages 8 - 10).
Point the remote control directly at the remote sensor on the unit.

The remote control can be used within the range shown below:
Press the ON/STAND-BY button. Does the power turn on? Now, you can enjoy music.

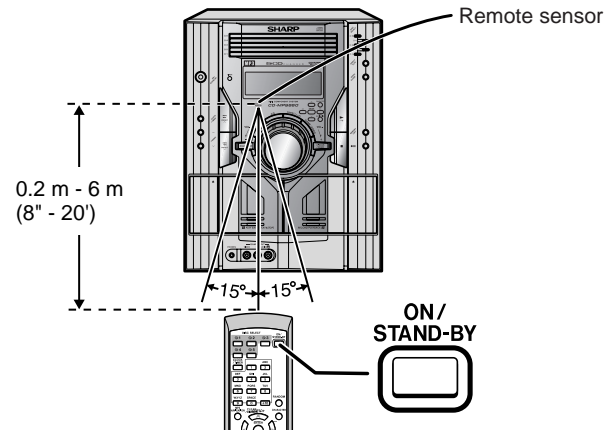

Preparation for Use

General control

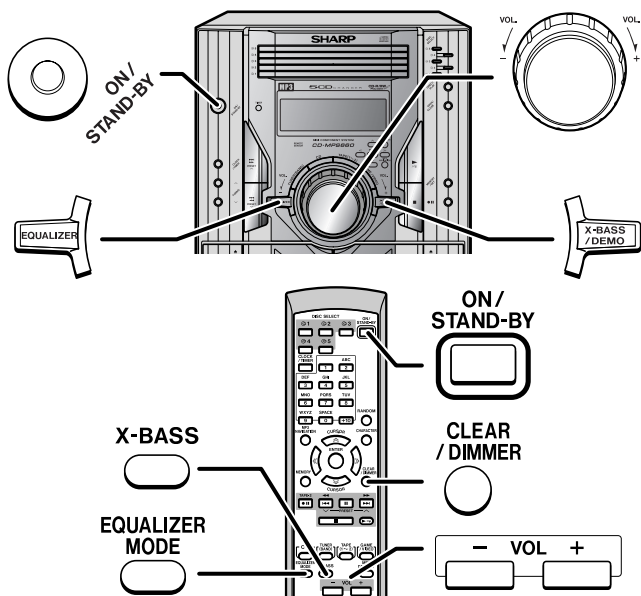

■ To turn the power on

Press the ON/STAND-BY button to turn the power on.

After use:

Press the ON/STAND-BY button to enter the power stand-by mode.

■ Illumination light control

When the power is turned on, light illuminates around the display. To turn on/off the light, hold down the CLEAR/DIMMER button on the remote control for 2 seconds or more.

■ Volume control

Main unit operation:

When the VOLUME control is turned clockwise, the volume will increase. When it is turned anti-clockwise, the volume will decrease.

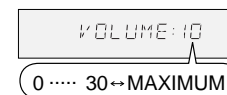

Remote control operation:

Press the VOLUME (+ or -) button to increase or decrease the volume.

■ Bass control (X-BASS)

When the power is first turned on, the unit will enter the extra bass mode which emphasises the bass frequencies, and "X-BASS" will appear. To cancel the extra bass mode, press the X-BASS/DEMO (X-BASS) button.

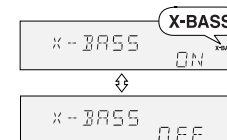

■ Equaliser

When the EQUALIZER (EQUALIZER MODE) button is pressed, the current mode setting will be displayed. To change to a different mode, press the EQUALIZER (EQUALIZER MODE) button repeatedly until the desired sound mode appears.

In CD/TUNER/TAPE mode	In GAME/VIDEO mode
→ FLAT	→ FLAT
↓	↓
ROCK	ROCK
↓	↓
CLASSIC	CLASSIC
↓	↓
POPS	ACTION
↓	↓
VOCAL	SPORTS
↓	↓
JAZZ	RACING

Setting the clock

CD-MPS660E

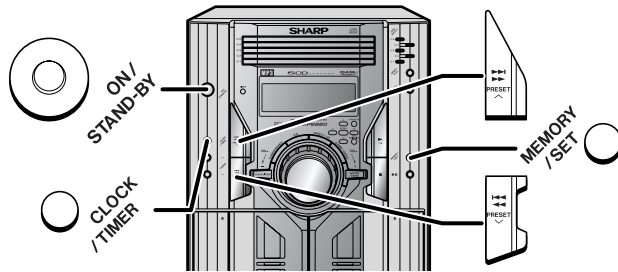

In this example, the clock is set for the 24-hour (0:00) display.

- 1 Press the ON/STAND-BY button to turn the power on.**
- 2 Press the CLOCK/TIMER button.**
- 3 Within 10 seconds, press the ◀◀◀ or ▶▶▶ button to select "CLOCK", and press the MEMORY/SET button.**
- 4 Press the ◀◀◀ or ▶▶▶ button to select 24-hour or 12-hour display and then press the MEMORY/SET button.**

"0:00"	→	The 24-hour display will appear. (0:00 - 23:59)
"AM 12:00"	→	The 12-hour display will appear. (AM 12:00 - PM 11:59)
"AM 0:00"	→	The 12-hour display will appear. (AM 0:00 - PM 11:59)

- 5 Press the ◀◀◀ or ▶▶▶ button to adjust the hour and then press the MEMORY/SET button.**



Press the ◀◀◀ or ▶▶▶ button once to advance the time by 1 hour. Hold it down to advance continuously.

- 6 Press the ◀◀◀ or ▶▶▶ button to adjust the minutes and then press the MEMORY/SET button.**



Press the ◀◀◀ or ▶▶▶ button once to advance the time by 1 minute. Hold it down to change the time in 5-minute intervals.

To confirm the time display:

[When the unit is in the stand-by mode]

Press the CLOCK/TIMER button.

The time display will appear for about 10 seconds.

[When the power is on]

Press the CLOCK/TIMER button.

Within 10 seconds, press the ◀◀◀ or ▶▶▶ button to display the time. The time display will appear for about 10 seconds.

Note:

The "CLOCK" will appear or time will flash to confirm the time display when the AC power supply is restored after a power failure or unplugging the unit. If incorrect, readjust the clock as follows.

To readjust the clock:

Perform "Setting the clock" from step 1. If the "CLOCK" does not appear in step 3, step 4 (for selecting the 24-hour or 12-hour display) will be skipped.

To change the 24-hour or 12-hour display:

- 1 Clear all the programmed contents. [Refer to "Clearing all the memory (reset)" on page 36 for details.]
- 2 Perform "Setting the clock" from step 1.

Note:

The clock can also be set with the remote control.

Listening to a CD or MP3 disc

This system can also play audio CD-R and CD-RW discs, but cannot record.

Some audio CD-R and CD-RW discs may not be playable due to the state of the disc or the equipment used for recording.

MP3 is a form of compression. It is an acronym which stands for MPEG Audio Layer 3.

MP3 is a type of audio code which is processed by significant compression from the original audio source with very little loss in sound quality.

Notes:

- "MP3" indicator will light up after the unit reads information on an MP3 disc.
- This system supports MPEG 1 Layer 3, MPEG 2 Layer 3, and VBR files.
- During VBR file playback, time counter in the display may differ from its actual playback time.



Auto power on function:

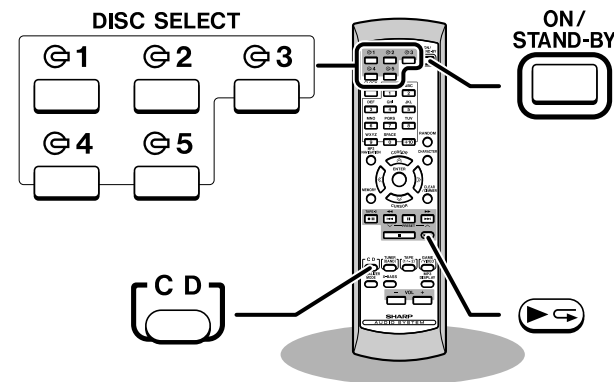
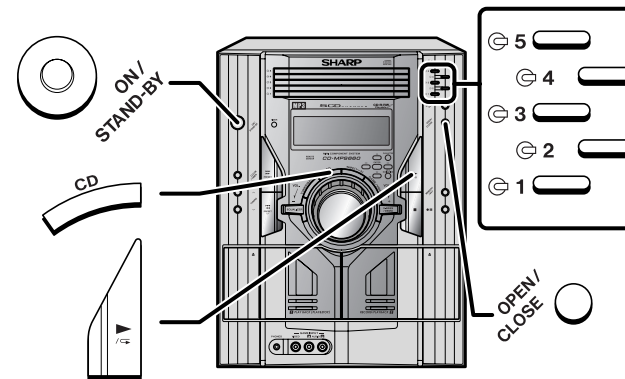

When you press any of the following buttons, the unit turns on.

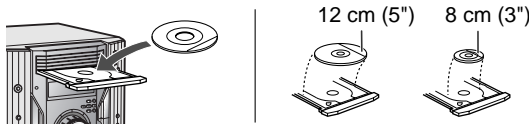
- CD button (main unit and remote control): The unit turns on and the "CD" function is activated.
- ▶ / ◀ button (main unit and remote control): The unit turns on and playback of the last function starts (CD/TAPE/TUNER/GAME).





- 1 Press the ON/STAND-BY button to turn the power on.**
- 2 Press the CD button.**
- 3 Press the  1 button and within 5 seconds, press the OPEN/CLOSE button to open the disc tray 1.**
- 4 Place the disc on the disc tray 1, label side up.**
Be sure to place 8 cm (3") disc in the middle of the disc trays.

- 5 Press the OPEN/CLOSE button to close the disc tray 1.**

<p>[CD]</p>  <p>Total number of tracks on the disc whose number is flashing</p> <p>Total playing time of the disc whose number is flashing</p>	<p>[MP3] MP3 disc indicator</p>  <p>Total number of folders</p> <p>Total number of files</p>
--	---



 - Due to the structure of its disc information, it takes longer to read an MP3 disc than a normal CD (approximately 20 to 90 seconds).
- 6 You can place discs on the trays 2 - 5 by following steps 3 - 5.**
- 7 Press the  /  button to start playback.**
 Disc play indicator

- Playback will begin from track 1 on the disc 1. After that disc finishes playing, the next disc will automatically play.
- After the last track on the fifth disc is played, the unit will stop automatically.
- When there is no disc in one of the disc trays (1 - 5), the empty tray will be skipped to the next tray with a disc.

To exchange other discs whilst playing a disc:

Press one of the  1 -  5 buttons for the stopped disc and within 5 seconds, press the OPEN/CLOSE button and exchange discs.

To remove the discs:











In the stop mode, press the  1 -  5 button and within 5 seconds, press the OPEN/CLOSE button.

Caution:

- Do not place two discs in one disc tray.
- Do not play discs with special shapes (heart- or octagon-shaped) as it may cause malfunctions.
- Do not push the disc tray whilst it is moving.
- If the power fails whilst the tray is open, wait until the power is restored.
- If the disc tray is stopped with force, "ER-CD20" will appear on the display for 3 seconds and the unit will not function. If this occurs, press the ON/STAND-BY button to enter the power stand-by mode and then turn the power on again.
- If TV or radio interference occurs during CD operation, move the unit away from the TV or radio.
- If a disc is damaged, dirty, or loaded upside down, the disc will skip or not play.

Listening to a CD or MP3 disc (continued)

■ Various disc functions

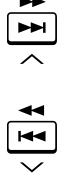
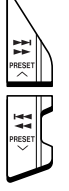
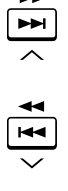
Function	Main unit	Remote control	Operation
Play 			Press in the stop mode.
Stop 			Press in the playback mode.
Pause 			Press in the playback mode. Press the ► / ◀ button to resume playback from the paused point.
Track up/ Track down			Press in the playback or stop mode. If you press the button in the stop mode, press the ► / ◀ button to start the desired track.
Fast forward/ Fast reverse			Press and hold down in the playback mode. Release the button to resume playback.

Notes:

- Track up/track down is possible only within individual discs.
- The sound is heard during fast forward/fast reverse with a CD, but not with an MP3 disc. For fast forward or fast reverse of an MP3 disc, refer to playback time on the display.

Notes for CD:

- Fast forward/fast reverse is possible only within individual discs.
- When the end of the last track is reached during fast forward, "xx END" will appear on the display and CD operation will be paused. When the beginning of the first track is reached during fast reverse, the unit will enter the playback mode. (xx: Last track number)

Notes for MP3 discs:

- Fast forward/fast reverse is possible only within individual tracks.
- When the end of the track is reached during fast forward, the next track will be played. Playback of the track will begin when its beginning is reached during fast reverse.

■ To change the display (MP3 discs only)

Whilst a disc is playing, press the MP3 DISPLAY button. Each time the button is pressed, the display will change as follows.

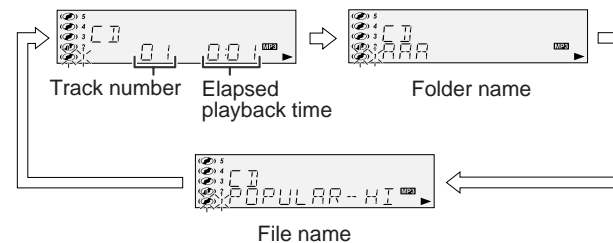
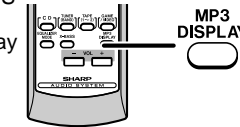

Advanced CD or MP3 disc playback

CD-MPS660E

■ To specify a disc to play

You can play a disc by specifying the disc number.

1 Press one of the 1 - 5 buttons to select the desired disc.

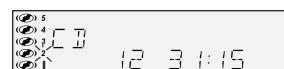

Selected disc number

2 Within 5 seconds, press the DIRECT PLAY button on the main unit.

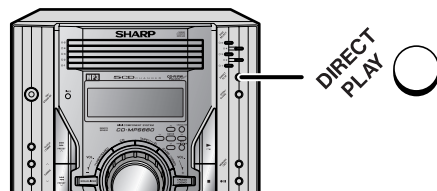

- Playback will begin from track 1 on the chosen disc.
- After the last track on the chosen disc is played, the unit stops automatically.

Note:

If a disc tray with no disc is selected, playback will not start and the disc indicator will go out.

To stop playback:

Press the ■ button.

■ Direct track search

By using the direct search buttons, the desired tracks on the current disc can be played.

Use the direct search buttons on the remote control to select the desired track whilst playing the selected disc.



Selected track number

- The direct search buttons allow you to select up to number 9.
- When selecting number 10 or higher, use the "+10" button.

A. For example, to choose 13

- 1 Press the "+10" button once.
- 2 Press the "3" button.

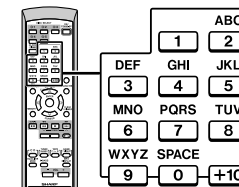

B. For example, to choose 30

- 1 Press the "+10" button three times.
- 2 Press the "0" button.

If the direct search buttons are pressed whilst the disc is stopped, press the ► / ◀ button to start the desired track on the current disc.

Notes:

- A track number higher than the number of tracks on the disc cannot be selected.
- During random play, direct search is not possible.

Advanced CD or MP3 disc playback (continued)

■ Repeat play

Repeat play can play all 5 discs, all tracks on a chosen disc, or a programmed sequence continuously.

To repeat all tracks on up to 5 discs:

Press the ► / ◀ button twice.

To repeat desired tracks:

Perform steps 1 - 6 in "Programmed play" section on page 19 and then press the ► / ◀ button twice.

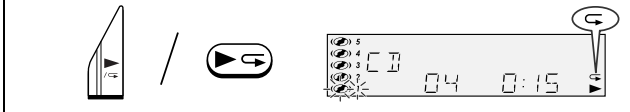

To cancel repeat play:

Press the ► / ◀ button again.

"R" will go out.

To repeat all tracks on the chosen disc:

- 1 Press one of the 1 - 5 buttons.
- 2 Within 5 seconds, press the DIRECT PLAY button twice.



To cancel repeat play:

Press the DIRECT PLAY button again.

"R" will go out.

■ Random play

The tracks on the disc(s) can be played in random order automatically.

To random play all tracks on up to 5 discs:

Press the RANDOM button on the remote control.

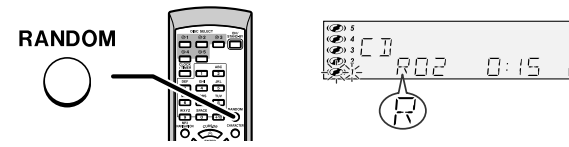

To cancel random play:

Press the ► / ◀ button.

"R" will go out.

To random play all tracks on the chosen disc:

- 1 Press one of the 1 - 5 buttons.
- 2 Within 5 seconds, press the DIRECT PLAY button.
- 3 Press the RANDOM button on the remote control.

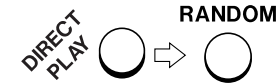

To cancel random play:

Press the DIRECT PLAY button.

"R" will go out.

Notes:

- If you press the ►► button during random play, you can move to the next track by the random operation. On the other hand, the ◀◀ button does not allow you to move to the previous track. The beginning of the track being played will be located.
- In random play, the unit will select and play tracks automatically. (You cannot select the order of the tracks.)

Caution:

After performing repeat or random play, be sure to press the ■ button. Otherwise, the disc(s) will play continuously.

■ Programmed play

You can choose up to 32 selections for playback in the order you like.

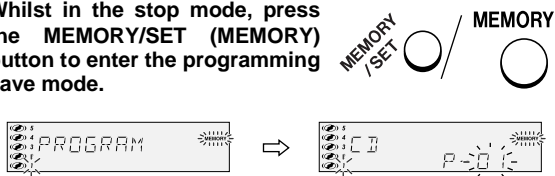
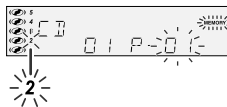
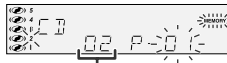
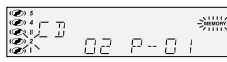
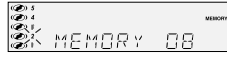
<p>1 Whilst in the stop mode, press the MEMORY/SET (MEMORY) button to enter the programming save mode.</p>	
<p>2 Press one of the 1 - 5 buttons to select the desired disc.</p>	 <p>Selected disc number</p>
<p>3 Press the direct search buttons on the remote control to select the desired track.</p>	 <p>Selected track number</p> <p>You can also select a track by pressing the ◀ or ▶ button.</p>
<p>4 Press the MEMORY/SET (MEMORY) button to save the track number.</p>	
<p>5 Repeat steps 2 - 4 for other tracks. Up to 32 tracks can be programmed.</p> <p>If you make a mistake, the programmed tracks can be cleared by pressing the CLEAR/DIMMER button.</p>	
<p>6 Press the ■ button.</p> <p>The total number of memory will appear.</p>	
<p>7 Press the ▶ / ⏪ button to start playback.</p>	

To clear the programmed selections:

Press the **CLEAR/DIMMER** button on the remote control whilst the "MEMORY" indicator is flashing. Each time the button is pressed, one track will be cleared, beginning with the last track programmed.

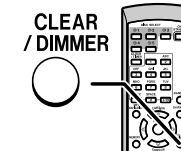

To cancel the programmed play mode:

Whilst in the stop mode and the "MEMORY" indicator is lit, press the **CLEAR/DIMMER** button on the remote control. The "MEMORY" indicator will disappear and all the programmed contents will be cleared.

Adding tracks to the programme:

If a programme has been previously stored, the "MEMORY" indicator will be displayed. Then follow steps 1 - 6 to add tracks. The new tracks will be stored after the last track of the original programme.

To check which tracks are programmed:

Whilst the unit is stopped in the programmed play mode, press the **◀** or **▶** button.

Notes:

- When a disc with programmed tracks is ejected, the programme is automatically cancelled.
- Even if you press the **ON/STAND-BY** button to enter the stand-by mode or change the function from CD to another, the programmed selections will not be cleared.
- During the programme operation, random play is not possible.
- During programmed play, the **DIRECT PLAY** button will not work.

MP3 navigation (only for MP3 files)

MP3 navigation:

You can search and play files by folder or title. For example, when you assign three titles to a file, enter genre (such as jazz) as title 1, album name as title 2, and music title as title 3 to search the file by any title.

- You can search and play files by folder or title 1/2/3 within one MP3 disc (see page 21).
- By entering a name, you can search files by folder or title 1/2/3 within one MP3 disc (see page 22).
- Folders or titles can be programmed within one MP3 disc (see page 23).

When you enter file names on your PC, connect words with hyphens. This product recognises the first word as title 1, second one as title 2, and third one as title 3. Up to three words can be recognised.

Example:

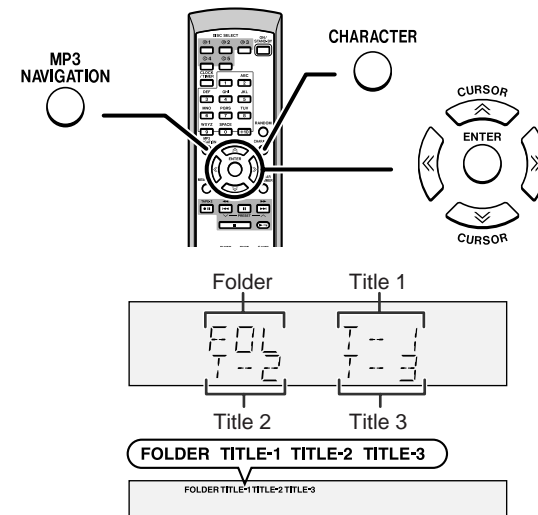
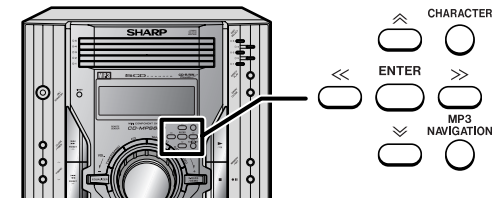
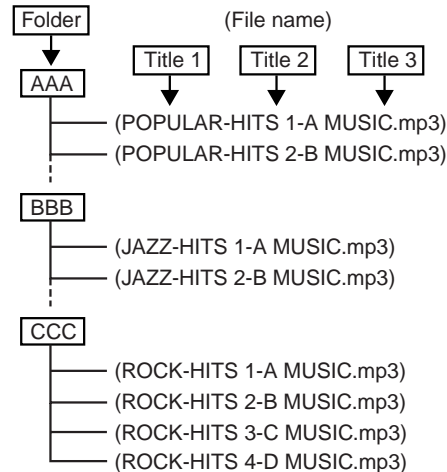

Notes:

- MP3 files must have the extension ".mp3".
- Up to 100 folders or 300 files can be read on the unit. If either limit is exceeded, no more folders/files are displayed.
- This unit recognises and displays up to 48 characters for folder names, and up to 32 characters for title 1/2/3.
- All file/folder names appear in uppercase.

■ File search (by folder or title 1/2/3)

You can search and play files by folder or title 1/2/3 within one MP3 disc.

1 Press one of the 1 - 5 buttons to select a disc tray containing an MP3 disc.

2 Press the ► / ◀ button, and the unit starts to read the MP3 disc.

3 Press the ■ button to stop playback.

"NAVI READ" appears and the display shows the total number of folders and files on the selected disc.

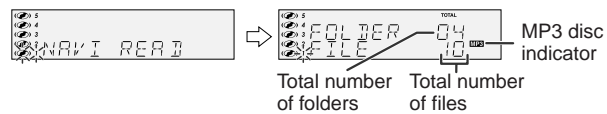

4 Press the MP3 NAVIGATION button.

5 Press the <<, >>, ≡ or ≡ button to select "FOL", "T-1", "T-2" or "T-3". To search files by folder name, select "FOL" (will flash).

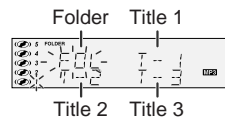

The following steps describe file search by folder:

6 Press the ENTER button.

The total number of folders (or titles) appears for 2 seconds, and names of the first 2 folders (or titles) are displayed.



- The MP3 NAVIGATION button allows you to go one step back.
- Press the MP3 DISPLAY button to check the number of files.



7 Use the ≡ or ≡ button to scroll and select a folder (or title), and then press the ENTER button.



If you press the ► / ◀ button instead of the ENTER button, all files in the selected folder (or title) are played.

8 Use the ≡ or ≡ button to scroll and select a file.

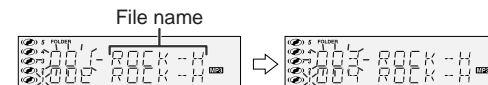

9 Press the ► / ◀ button to start playback.

The unit plays from the selected file to the last file in the selected folder (or title), and the previous display returns.

File search by title 1/2/3:

- In step 5, select "T-1", "T-2" or "T-3" and follow the same steps as file search by folder.
- The unit searches all files on the disc, regardless of the folder.

To stop playback:

Press the ■ button.

To exit the MP3 navigation mode:

In the stop mode, press the ■ button.

Notes:

- In the MP3 navigation mode, direct play and direct search functions are disabled.
- If a folder, title or file name does not appear, or appears incorrectly, remove and reinsert the disc and try again.
- If you press the RANDOM button in the stop mode, the MP3 navigation mode will be cancelled.

MP3 navigation (only for MP3 files) (continued)

■ Character search (for folder or title 1/2/3)

By entering a name, you can search files by folder or title 1/2/3 within one MP3 disc.

1 Perform steps 1 - 3 in "File search (by folder or title 1/2/3)" on page 21.

2 Press the MP3 NAVIGATION button.

3 Press the \ll , \gg , \wedge or \vee button to select "FOL", "T-1", "T-2" or "T-3". To search files by folder name, select "FOL" (will flash).

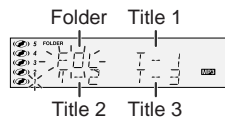

4 Press the CHARACTER button for 2 seconds.

The display will be ready for editing characters.

1st row: String table

2nd row: Input editor (8 digits)



5 Press the \ll or \gg button to select the desired alphabet.

Press the \lll or \ggg button to go to the next page of character display.

6 Press the CHARACTER button and the active character will be entered in the 2nd row of the display.



To delete an entered character, move the cursor to the character with the \wedge or \vee button and press the CLEAR/DIMMER button on the remote control.

7 Repeat steps 5 and 6 to enter characters.

In the folder (or title) name search, you do not have to enter the full name. The unit searches for names beginning with the entered characters.

8 When finished, press the ENTER button. The unit searches for the same name within folders (or titles).



If the search word is not in the folder (or title) name, "NOT FOUND" appears and the menu returns.

9 Use the \wedge or \vee button to scroll and select a folder (or title).

10 Press the \triangleright / \square button to start playback.

All files in the selected folder (or title) are played, and the previous display returns.

To exit the MP3 navigation mode:

In the stop mode, press the \blacksquare button.

Notes:

- The unit searches regardless of the case, and found names appear in uppercase.
- Some symbols do not appear properly.

Character entry with direct buttons:

The direct buttons on the remote control can also be used for character entry.

In step 5 on the left, use buttons 0 - 9 to enter alphabets.

Alphabet types change as you press a button.

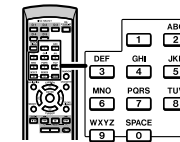

For example, press "2" four times to enter "C".

2 \rightarrow A \rightarrow B \rightarrow C

Characters:

1	ABC	DEF	GHI	JKL	MNO	PQRS	TUV	WXYZ	SPACE
1	2 ABC	3 DEF	4 GHI	5 JKL	6 MNO	7 PQRS	8 TUV	9 WXYZ	0 []

[] : indicates a space.

■ Programmed play (for folder, title 1/2/3)

Folders or titles can be programmed within one MP3 disc. Folder, title 1, title 2 and title 3 cannot be programmed together simultaneously.

- 1 Perform steps 1 - 3 in "File search (by folder or title 1/2/3)" on page 21.**
- 2 Press the MP3 NAVIGATION button.**
- 3 Press the «, », ⌂ or ≡ button to select "FOL", "T-1", "T-2" or "T-3" and then press the ENTER button.**
The total number of folders (or titles) appears for 2 seconds, and names of the first 2 folders (or titles) are displayed.
- 4 Press the ⌂ or ≡ button to select the desired folder (or title) and then press the MEMORY button.**

The folder (or title) is memorised with all the files.
- 5 Repeat step 4 for other folders (or titles).**
Up to 10 folders (or 10 titles) can be programmed.
- 6 Press the ► / ◀ button to start playback.**

Programmed play will always start from the smallest folder (or title) number.

To stop playback:

Press the ■ button.

- The programmed contents are not cleared.

To check, add or delete programmed contents:

In the stop mode, select a folder (or title) with the ⌂ or ≡ button. If the folder (or title) is programmed, "MEMORY" flashes.

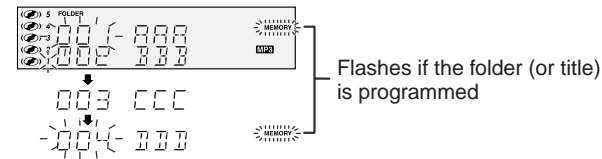

- When you press the MEMORY button with "MEMORY" flashing, the folder (or title) is removed from the programme.
- If you press the MEMORY button with "MEMORY" off, the folder (or title) is added to the programme.
- To clear all programmes, press the CLEAR/DIMMER button in the stop mode.

To exit the MP3 navigation mode:

In the stop mode, press the ■ button.

- The programmed contents are cleared.

Notes:

- The programmed contents are cleared when you eject a disc, play another disc, switch the function, or enter the stand-by mode with the ON/STAND-BY button.
- During programmed play, the DIRECT PLAY button on the main unit will not work.
- If you press the RANDOM button in the stop mode, the MP3 navigation mode will be cancelled.

If tracks are programmed using track numbers (see "Programmed play" on page 19):

In the MP3 navigation mode, only programmes by folder (or title) name are played. When you exit the mode, the programmes by folder (or title) name are cleared.

Even when you exit the MP3 navigation mode, programmes by track number are retained, and you can play tracks according to the numbers.

(Programmes by track number are cleared when you remove the disc.)

Listening to the radio

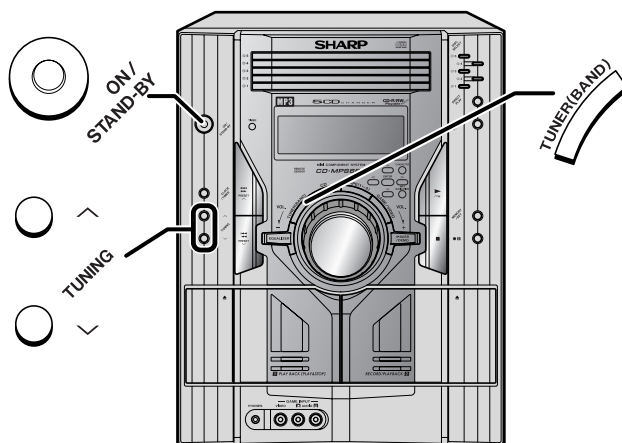

Auto power on function:

When you press any of the following buttons, the unit turns on.

- TUNER (BAND) button (main unit and remote control): The unit turns on and the "TUNER" function is activated.
- ► / ◀ button (main unit and remote control): The unit turns on and playback of the last function starts (CD/TAPE/TUNER/GAME).

Note:

This product can receive FM stereo/FM monaural and AM monaural broadcasts. AM stereo broadcasts will not be played in stereo.

■ Tuning

- 1 Press the ON/STAND-BY button to turn the power on.
- 2 Press the TUNER (BAND) button repeatedly to select the desired frequency band (FM or AM).
- 3 Press the TUNING (∨ or ∧) button to tune in to the desired station.

Manual tuning:

Press the TUNING button as many times as required to tune in to the desired station.

Auto tuning:

When the TUNING button is pressed for more than 0.5 seconds, scanning will start automatically and the tuner will stop at the first receivable broadcast station.

Notes:

- When radio interference occurs, auto scan tuning may stop automatically at that point.
- Auto scan tuning will skip weak signal stations.
- To stop the auto tuning, press the TUNING button again.

To receive an FM stereo transmission:

Press the TUNER (BAND) button to display the "ST" indicator.

- "∞" will appear when an FM broadcast is in stereo.
- If the FM reception is weak, press the TUNER (BAND) button to extinguish the "ST" indicator. The reception changes to monaural, and the sound becomes clearer.

FM stereo mode indicator

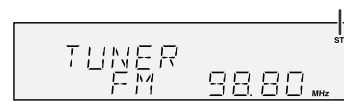

FM stereo receiving indicator

■ Memorising a station

You can store 40 AM and FM stations in memory and recall them at the push of a button. (Preset tuning)

1 Perform steps 1 - 3 in "Tuning" on page 24.

2 Press the MEMORY/SET (MEMORY) button to enter the preset tuning saving mode.

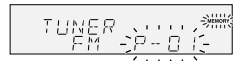

3 Within 30 seconds, press the PRESET (∨ or ∧) button to select the preset channel number.

Store the stations in memory, in order, starting with preset channel 1.

4 Within 30 seconds, press the MEMORY/SET (MEMORY) button to store that station in memory.

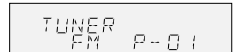

If the "MEMORY" and preset number indicators go out before the station is memorised, repeat the operation from step 2.

5 Repeat steps 1 - 4 to set other stations, or to change a preset station.

When a new station is stored in memory, the station previously memorised will be erased.

Note:

The backup function protects the memorised stations for a few hours should there be a power failure or the AC power lead disconnection.

■ To recall a memorised station

Press the PRESET (∨ or ∧) button for less than 0.5 seconds to select the desired station.

■ To scan the preset stations

The stations saved in memory can be scanned automatically. (Preset memory scan)

- 1 Press the PRESET (∨ or ∧) button for more than 0.5 seconds. The preset number will flash and the programmed stations will be tuned in sequentially, for 5 seconds each.
- 2 Press the PRESET (∨ or ∧) button again when the desired station is located.

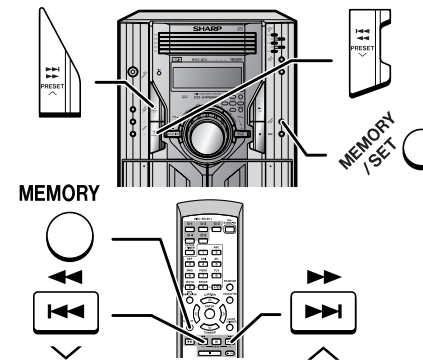

■ To erase entire preset memory

- 1 Press the ON/STAND-BY button to enter the stand-by mode.
- 2 Whilst pressing down the X-BASS/DEMO button and the X-BASS/DEMO button, press the CLOCK/TIMER button until "TUNER CL" appears.



Listening to a cassette tape (TAPE 1 or TAPE 2)

Before playback:

- For playback, use normal or low-noise tapes for the best sound. (Metal or CrO₂ tapes are not recommended.)
- Do not use C-120 tapes or poor-quality tapes, as they may cause malfunctions.
- Before loading a tape into the cassette compartment, tighten the slack with a pen or a pencil.

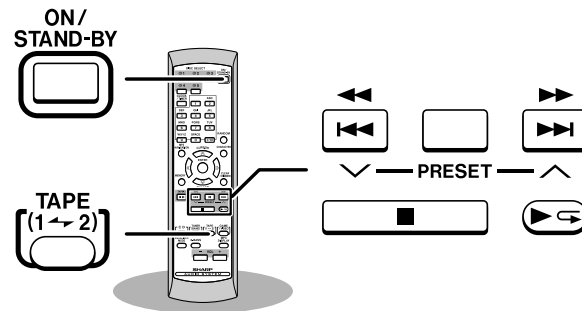
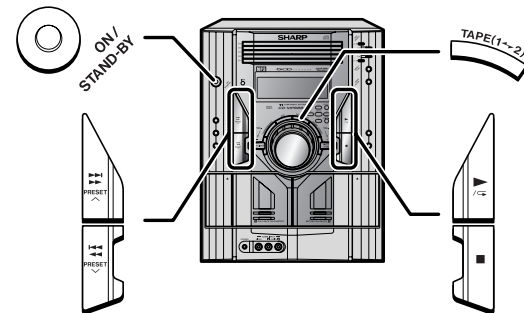
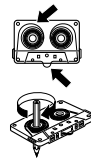

■ Tape playback

1 Press the ON/STAND-BY button to turn the power on.

2 Open the cassette compartment by pushing the area marked "▲".

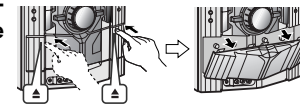

3 Load a cassette into the TAPE 1 compartment or TAPE 2 compartment with the side to be played facing toward you.

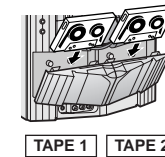

4 Press the TAPE (1 → 2) button to select the cassette you want to listen to.



5 Press the ► / ◀ button to start playback.

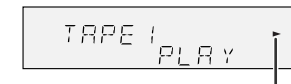









Tape play indicator

Auto power on function:

When you press any of the following buttons, the unit turns on.

- TAPE (1 → 2) button (main unit and remote control): The unit turns on and the "TAPE" function is activated.
- ► / ◀ button (main unit and remote control): The unit turns on and playback of the last function starts (CD/TAPE/TUNER/GAME).

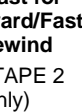
■ Various tape functions

Function	Main unit	Remote control	Operation
Play 			Press in the stop mode.
Stop 			Press in the playback, fast forward or fast rewind mode.
Fast forward/Fast rewind (TAPE 2 only) 			Press in the playback or stop mode.

Caution:

- To remove the cassette, press the ■ button, and then open the compartment.
- Before changing from one tape operation to another, press the ■ button.
- If a power failure occurs during tape operation, the tape head will remain engaged with the tape and the cassette door will not open. In this case, wait until the power is restored.

Recording on a cassette tape

Before recording:

- When recording important selections, make a preliminary test to ensure that the desired material is properly recorded.
- SHARP is not liable for damage or loss of your recording arising from malfunction of this unit.
- The volume and sound controls can be adjusted with no effect on the recorded signal (Variable Sound Monitor).
- **For recording, use only normal tapes. Do not use metal or CrO₂ tapes.**

Erase-prevention tab of cassette tapes:

- When recording on a cassette tape, make sure that the erase-prevention tabs are not removed. Cassettes have removable tabs that prevent accidental recording or erasing.
- To protect the recorded sound, remove the tab after recording. Cover the tab hole with adhesive tape to record on the tape without the tab.

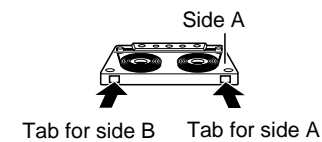

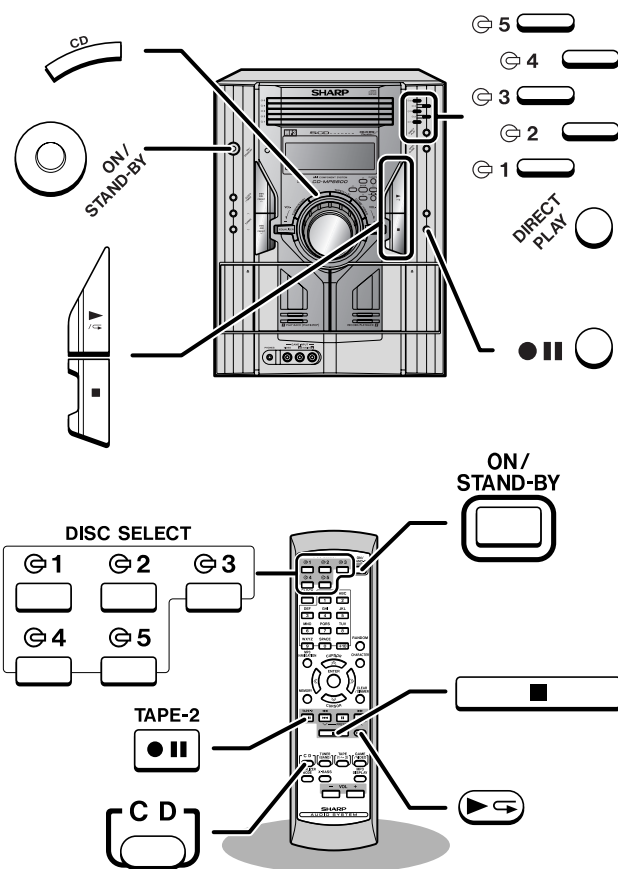

Recording on a cassette tape (continued)



■ Recording from a CD or MP3 disc

You can record the desired disc using the DIRECT PLAY button.

- 1 Press the ON/STAND-BY button to turn the power on.**
- 2 Press the CD button.**
- 3 Load a cassette into the TAPE 2 cassette compartment with the side to be recorded on facing you.**
Wind past the leader of the tape, on which recording cannot be performed.
- 4 Press the  button.**
Recording will be paused.
- 5 Press one of the  buttons to select the desired disc.**
- 6 Within 5 seconds, press the DIRECT PLAY button to start recording.**
 - Recording is started from the selected disc. When the playback of the last track is finished or the end of the tape is reached, the disc and the cassette will stop automatically.
 - Playback of the disc will start approximately 7 seconds after the tape starts.

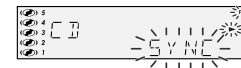

To stop recording:

Press the  button.
The disc and tape will stop.

Sequential recording from several discs:

- 1 Perform steps 1 - 5 in "Recording from a CD or MP3 disc" on page 28.
- 2 Within 5 seconds, press the ► / ◀ button.

To perform programmed recording:

- 1 Programme discs and tracks (see pages 19, 23).
- 2 Press the ●|| button.
- 3 Press the ► / ◀ button.

To stop recording:

Press the ■ button.
The disc and tape will stop.

■ Recording from the radio

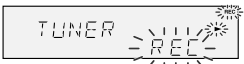
- 1 Tune in to the desired station (see page 24).
- 2 Load a cassette into the TAPE 2 cassette compartment with the side to be recorded on facing you.
Wind past the leader of the tape, on which recording cannot be performed.
- 3 Press the ●|| button.
Recording will be paused. 
- 4 Press the ► / ◀ button to start recording.

To interrupt recording:

Press the ●|| button.
To resume recording, press the ► / ◀ button.

To stop recording:



Press the ■ button.

Note:

If you hear a whistling noise whilst recording an AM station, move the AM loop aerial.

■ Dubbing from tape to tape

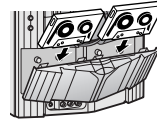
You can record from TAPE 1 to TAPE 2.

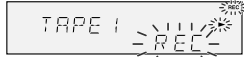
- 1 Press the ON/STAND-BY button to turn the power on.
- 2 Load a prerecorded cassette into the TAPE 1 cassette compartment. Insert a blank tape into the TAPE 2 cassette compartment. 

- 3 Press the TAPE (1 → 2) button until "TAPE 1" appears on the display.
- 4 Press the ●|| button.
Recording will be paused. 
- 5 Press the ► / ◀ button to start dubbing.

To stop dubbing:

Press the ■ button.
TAPE 1 and TAPE 2 will simultaneously stop.

■ Erasing recorded tapes

- 1 Load the tape to be erased into the TAPE 2 cassette compartment with the side to be erased facing toward you.
- 2 Press the TAPE (1 → 2) button until "TAPE 2" appears on the display.
- 3 Press the ●|| button.
- 4 Press the ► / ◀ button to start erasing.

Note:

Make sure that the TAPE 1 is not in use.

Timer and sleep operation

Timer playback:

The unit turns on and plays the desired source (CD, MP3 disc, tuner, tape) at a preset time.

Timer recording:

The unit turns on and starts recording from the tuner at the preset time.

This unit has 2 types of timer: ONCE TIMER and DAILY TIMER.

Once timer: Once timer play or once timer recording works for one time only at a preset time.

For example, if you are away but want to record a programme on a radio station.

Daily timer: Daily timer play or daily timer recording works at the same preset time every day.

For example, set the timer as a wake-up call every morning.

Using the once timer and daily timer in combination:

For example, use the once timer to record a radio programme, and use the daily timer to wake up.

- 1 Set the daily timer (pages 30 - 32).
- 2 Set the once timer (pages 30 - 32).

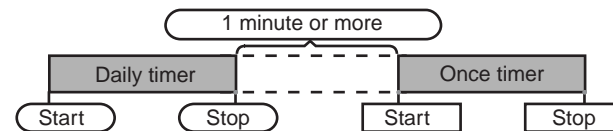

Note:

When set times for the daily timer and once timer overlap, the once timer takes priority. Allow an interval of at least 1 minute between operations.

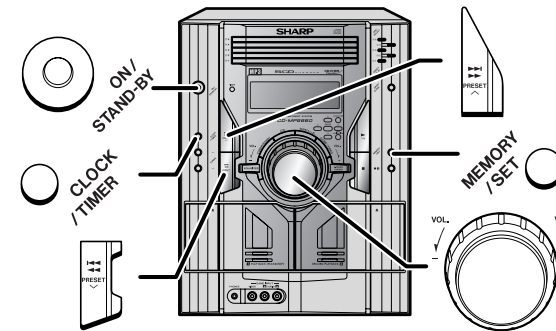

■ Timer playback or timer recording

Before setting timer:

- 1 Check that the clock is set to the correct time (refer to page 13). If it is not set, you cannot use the timer function.
- 2 For timer playback: Load a cassette or discs to be played.
For timer recording: Load a cassette for recording in the cassette compartment.



- 1 Press the ON/STAND-BY button to turn the power on.
- 2 Press the CLOCK/TIMER button.
- 3 Within 10 seconds, press the <<<< or >>>> button to select "ONCE" or "DAILY", and press the MEMORY/SET button.



Set the clock to the correct time if "ONCE" or "DAILY" does not appear.

- 4** Within 10 seconds, press the **◀◀◀◀** or **▶▶▶▶** button to select "ONCE SET" or "DAILY SET", and press the MEMORY/SET button.



- 5** Press the **◀◀◀◀** or **▶▶▶▶** button to select "PLAY" or "REC", and press the MEMORY/SET button.



The illustrations show the daily timer setting.

- 6** Press the **◀◀◀◀** or **▶▶▶▶** button to adjust the hour and then press the MEMORY/SET button.



The illustrations show the timer playback setting in the daily timer mode.

- 7** Press the **◀◀◀◀** or **▶▶▶▶** button to adjust the minutes and then press the MEMORY/SET button.



- 8** Set the time to finish as in steps 6 and 7 above.

- 9** Switch input with the **◀◀◀◀** or **▶▶▶▶** button, and then press the MEMORY/SET button.

To select the timer playback source: CD, TUNER, TAPE 1 or TAPE 2.

To select the timer recording source: TUNER.

- When you select the tuner, select a station by pressing the **◀◀◀◀** or **▶▶▶▶** button, and then press the MEMORY/SET button.
- If a station has not been programmed, "NO PRESET" will be displayed and timer setting will be cancelled.

- 10** Adjust the volume using the VOLUME control, and then press the MEMORY/SET button.

Do not turn the volume up too high.

- 11** Press the ON/STAND-BY button to enter the power stand-by mode.

The "TIMER" indicator lights up and the unit is ready for timer playback or timer recording.

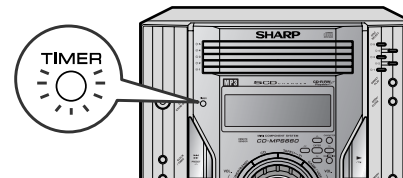

Continued to the next page

Timer and sleep operation (continued)

12 When the preset time is reached, playback or recording will start.

The volume will increase gradually until it reaches the preset volume.

13 When the timer end time is reached, the system will enter the power stand-by mode automatically.

Once timer:

The timer will be cancelled.

Daily timer:

The timer will operate at the same time every day. It will continue until the daily timer setting is cancelled. Cancel the daily timer when it is not in use.

Note:

When performing timer playback or recording using another unit connected to the GAME INPUT sockets, select "GAME" in step 9. This unit will turn on or enter the power stand-by mode automatically, however, the connected unit will not turn on or off.

Checking the timer setting in the timer stand-by mode:

- 1 Press the CLOCK/TIMER button.
- 2 Within 10 seconds, press the **◀◀◀** or **▶▶▶** button to select "ONCE" or "DAILY", and press the MEMORY/SET button.
- 3 Within 10 seconds, press the **◀◀◀** or **▶▶▶** button to select "ONCE CALL" or "DAILY CALL", and press the MEMORY/SET button.
The unit returns to the timer stand-by mode after displaying the settings in order.

Cancelling the timer setting in the timer stand-by mode:

- 1 Press the CLOCK/TIMER button.
- 2 Within 10 seconds, press the **◀◀◀** or **▶▶▶** button to select "ONCE" or "DAILY", and press the MEMORY/SET button.
- 3 Within 10 seconds, press the **◀◀◀** or **▶▶▶** button to select "ONCE OFF" or "DAILY OFF", and press the MEMORY/SET button.
Timer will be cancelled (the setting will not be cancelled).

Reusing the memorised timer setting:

The timer setting will be memorised once it is entered. To reuse the same setting, perform the following operations.

- 1 Turn the power on and press the CLOCK/TIMER button.
- 2 Within 10 seconds, press the **◀◀◀** or **▶▶▶** button to select "ONCE" or "DAILY", and press the MEMORY/SET button.
- 3 Within 10 seconds, press the **◀◀◀** or **▶▶▶** button to select "ONCE ON" or "DAILY ON", and press the MEMORY/SET button.
- 4 Press the ON/STAND-BY button to enter the power stand-by mode.

Note:

The timer can also be set with the remote control.

■ Sleep operation

The radio, CD, MP3 disc and cassette tape can all be turned off automatically.

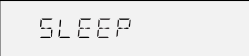
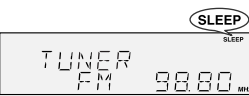
1	Play back the desired sound source.
2	Press the CLOCK/TIMER button.
3	Within 10 seconds, press the ◀◀◀ or ▶▶▶ button to select "SLEEP", and press the MEMORY/SET button. 
4	Press the ◀◀◀ or ▶▶▶ button to select the time. (Maximum: 3 hours - Minimum: 1 minute) ● 3 hours - 5 minutes → 5-minute intervals ● 5 minutes - 1 minute → 1-minute intervals
5	Press the MEMORY/SET button. "SLEEP" will appear. 
6	The unit will enter the power stand-by mode automatically after the preset time has elapsed. The volume will be turned down 1 minute before the sleep operation finishes.

To confirm the remaining sleep time:

- 1 Whilst "SLEEP" is indicated, press the CLOCK/TIMER button.
 - 2 Within 10 seconds, press the **◀◀◀** or **▶▶▶** button to select "SLEEP X : XX".
"X : XX" is remaining sleep time.
- The remaining sleep time is displayed for about 10 seconds.
 - You can change the remaining sleep time whilst it is displayed by pressing the MEMORY/SET button.

To cancel the sleep operation:

Press the ON/STAND-BY button whilst "SLEEP" is indicated. To cancel the sleep operation without setting the system to the stand-by mode, proceed as follows.

- 1 Whilst "SLEEP" is indicated, press the CLOCK/TIMER button.
- 2 Within 10 seconds, press the **◀◀◀** or **▶▶▶** button to select "SLEEP OFF", and press the MEMORY/SET button.

■ To use timer and sleep operation together

Sleep and timer playback:

For example, you can fall asleep listening to the radio and wake up to CD in the next morning.

Sleep and timer recording:

For example, you can fall asleep listening to the CD and record radio programmes whilst sleeping.

- 1 Set the sleep time (see left, steps 1 - 5).
- 2 Whilst the sleep timer is set, set the timer playback or recording (steps 2 - 10, pages 30 - 31).

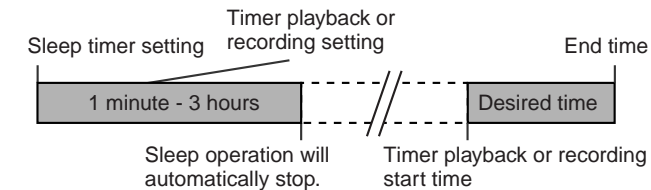

Caution:

When using the cassette deck, be sure the tape length is long enough to perform both functions. If you want to sleep and wake up listening to a tape, and the length of the tape is shorter than the sleep timer setting, timer playback or recording will not be possible.

Enhancing your system

The connection lead is not included. Purchase a commercially available lead as shown below.

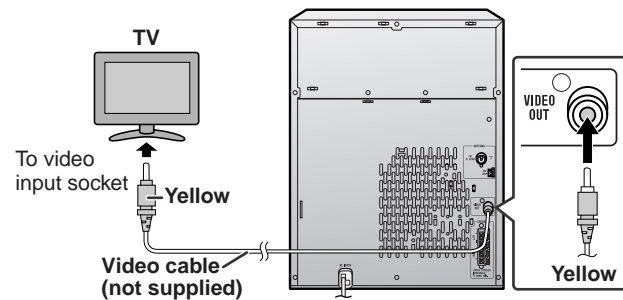
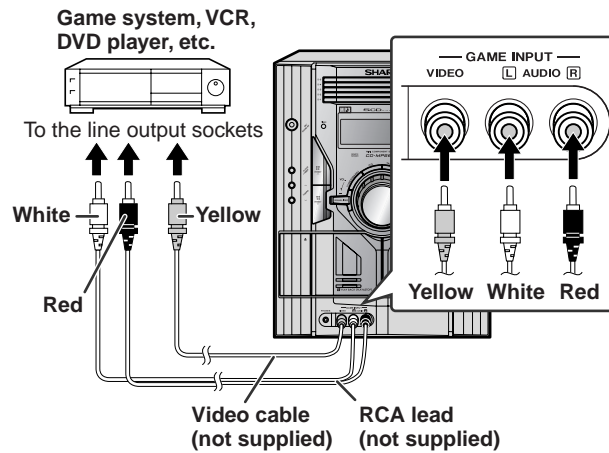

■ Listening to sounds of game, VCR, DVD, etc.

1 Connect a video game system, VCR, DVD, etc. to the front GAME INPUT (VIDEO, AUDIO L and R) sockets.

2 Connect a TV to the rear VIDEO OUT socket.

Switch the TV input to auxiliary.

3 Press the ON/STAND-BY button to turn the power on.

4 Press the GAME/VIDEO button.

5 Play the connected equipment.

You can enjoy sounds from the supplied speakers and images on the TV.

Note:

To prevent noise interference, place the unit away from the television.

Auto power on function:

When you press any of the following buttons, the unit turns on.

- GAME/VIDEO button (main unit and remote control): The unit turns on and the "GAME" function is activated.
- ► / ◀ button (main unit and remote control): The unit turns on and playback of the last function starts (CD/TAPE/TUNER/GAME).

■ To record sounds of game, VCR, etc.

1 Insert a cassette in the TAPE 2 cassette compartment.

2 Press the GAME/VIDEO button.

3 Press the ●|| button.

4 Press the ► / ◀ button.

5 Start the game system, VCR, etc.

■ Headphones

- Before plugging in or unplugging the headphones, reduce the volume.
- Be sure your headphones have a 3.5 mm (1/8") diameter plug and are between 16 ohms and 50 ohms impedance. The recommended impedance is 32 ohms.
- Plugging in the headphones disconnects the speakers automatically. Adjust the volume using the VOLUME control.

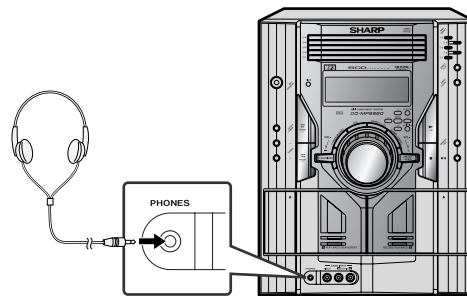

Troubleshooting chart

Many potential problems can be resolved by the owner without calling a service technician. If something is wrong with this product, check the following before calling your authorised SHARP dealer or service centre.

■ General

Symptom	Possible cause
<ul style="list-style-type: none"> ● The clock is not set to the correct time. 	<ul style="list-style-type: none"> ● Did a power failure occur? Reset the clock. (Refer to page 13.)
<ul style="list-style-type: none"> ● When a button is pressed, the unit does not respond. 	<ul style="list-style-type: none"> ● Set the unit to the power standby mode and then turn it back on. ● If the unit still malfunctions, reset it. (Refer to page 36.)
<ul style="list-style-type: none"> ● No sound is heard. 	<ul style="list-style-type: none"> ● Is the volume level set to "0"? ● Are the headphones connected? ● Are the speaker wires disconnected?

■ CD player

Symptom	Possible cause
<ul style="list-style-type: none"> ● Playback does not start. ● Playback stops in the middle or is not performed properly. 	<ul style="list-style-type: none"> ● Is the disc loaded upside down? ● Does the disc satisfy the standards? ● Is the disc distorted or scratched?
<ul style="list-style-type: none"> ● Playback sounds are skipped, or stopped in the middle of a track. 	<ul style="list-style-type: none"> ● Is the unit located near excessive vibrations? ● Is the disc very dirty? ● Has condensation formed inside the unit?

Troubleshooting chart (continued)

■ Cassette deck

Symptom	Possible cause
<ul style="list-style-type: none"> ● Cannot record. 	<ul style="list-style-type: none"> ● Is the erase-prevention tab removed?
<ul style="list-style-type: none"> ● Cannot record tracks with proper sound quality. ● Cannot erase completely. 	<ul style="list-style-type: none"> ● Is it a normal tape? (You cannot record on a metal or CrO₂ tape.)
<ul style="list-style-type: none"> ● Sound skipping. 	<ul style="list-style-type: none"> ● Is there slack in the tape? ● Is the tape stretched?
<ul style="list-style-type: none"> ● Cannot hear treble. ● Sound fluctuation. 	<ul style="list-style-type: none"> ● Are the capstans, pinch rollers, or heads dirty?
<ul style="list-style-type: none"> ● Cannot remove the tape. 	<ul style="list-style-type: none"> ● If a power failure occurs during playback, the heads remain engaged with the tape. Do not open the compartment with great force.

■ Remote control

Symptom	Possible cause
<ul style="list-style-type: none"> ● The remote control does not operate. 	<ul style="list-style-type: none"> ● Is the AC power lead of the unit plugged in? ● Is the battery polarity correct? ● Are the batteries dead? ● Is the distance or angle incorrect? ● Does the remote control sensor receive strong light?

■ Tuner

Symptom	Possible cause
<ul style="list-style-type: none"> ● The radio makes unusual noises continuously. 	<ul style="list-style-type: none"> ● Is the unit placed near the TV or computer? ● Is the FM aerial or AM loop aerial placed properly? Move the aerial away from the AC power lead if it's located nearby.

■ If trouble occurs

When this product is subjected to strong external interference (mechanical shock, excessive static electricity, abnormal supply voltage due to lightning, etc.) or if it is operated incorrectly, it may malfunction.

If such a problem occurs, do the following:

- 1 Set the unit to the stand-by mode and turn the power on again.
- 2 If the unit is not restored in the previous operation, unplug and plug in the unit, and then turn the power on.

Note:

If neither operation above restores the unit, clear all the memory by resetting it.

■ Clearing all the memory (reset)

- 1 Press the ON/STAND-BY button to enter the power stand-by mode.
- 2 Whilst pressing down the ●|| button and the X-BASS/DEMO button, press the ◀◀ PRESET ∨ button until "CLEAR ALL" appears.

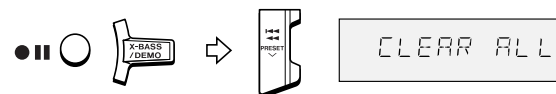

Caution:

This operation will erase all data stored in memory including clock, timer settings, tuner preset, and CD programme.

■ Condensation

Sudden temperature changes, storage or operation in an extremely humid environment may cause condensation inside the cabinet (CD pickup, tape heads, etc.) or on the transmitter on the remote control. Condensation can cause the unit to malfunction. If this happens, leave the power on with no disc (or cassette) in the unit until normal playback is possible (about 1 hour). Wipe off any condensation on the transmitter with a soft cloth before operating the unit.

■ Before transporting the unit

Remove all CDs from the unit. Make sure there is no CD in the disc tray. Then, set the unit to the power stand-by mode. Carrying the unit with discs left inside can damage the unit.

■ Care of compact discs

Compact discs are fairly resistant to damage, however mistracking can occur due to an accumulation of dirt on the disc surface. Follow the guidelines below for maximum enjoyment from your CD collection and player.

- Do not write on either side of the disc, particularly the non-label side from which signals are read. Do not mark this surface.
- Keep your discs away from direct sunlight, heat, and excessive moisture.
- Always hold the CDs by the edges. Fingerprints, dirt, or water on the CDs can cause noise or mistracking. If a CD is dirty or does not play properly, clean it with a soft, dry cloth, wiping straight out from the centre, along the radius.

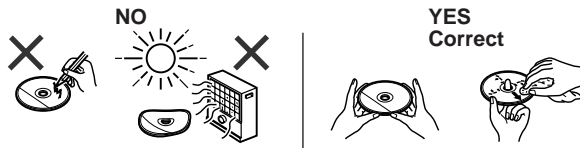

Maintenance

CD-MPS660E

■ Cleaning the tape-handling parts

- Dirty heads, capstans or pinch rollers can cause poor sound and tape jams. Clean these parts with a cotton swab moistened with commercial head/pinch roller cleaner or isopropyl alcohol.
- When cleaning the heads, pinch rollers, etc., unplug the unit which contains high voltages.

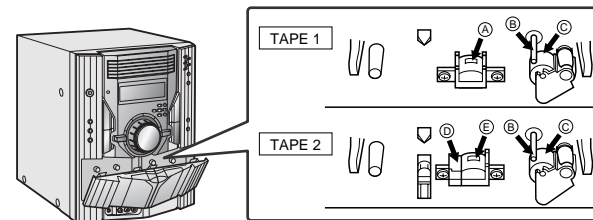

- Ⓐ Playback head
- Ⓑ Capstan
- Ⓒ Pinch roller
- Ⓓ Erase head
- Ⓔ Recording/Playback head

- After long use, the deck's heads and capstans may become magnetised, causing poor sound. Demagnetise these parts once every 30 hours of playing/recording time by using a commercial tape head demagnetiser. Read the demagnetiser's instructions carefully before use.

■ Cleaning the cabinet

Periodically wipe the cabinet with a soft cloth and a diluted soap solution, then with a dry cloth.

Caution:

- Do not use chemicals for cleaning (petrol, paint thinner, etc.). It may damage the cabinet finish.
- Do not apply oil to the inside of the unit. It may cause malfunctions.

Specifications

As part of our policy of continuous improvement, SHARP reserves the right to make design and specification changes for product improvement without prior notice. The performance specification figures indicated are nominal values of production units. There may be some deviations from these values in individual units.

■ General

Power source	AC 230 - 240 V, 50 Hz
Power consumption	110 W
Dimensions	Width: 260 mm (10-1/4") Height: 330 mm (13") Depth: 326 mm (12-7/8")
Weight	7.8 kg (17.2 lbs.)

■ Amplifier

Output power	MPO: 440 W (220 W + 220 W) (10 % T.H.D.) RMS: 240 W (120 W + 120 W) (10 % T.H.D.) RMS: 160 W (80 W + 80 W) (0.9 % T.H.D.)
Output terminals	Speakers: 6 ohms Headphones: 16 - 50 ohms (recommended: 32 ohms) Video output: 1Vp-p
Input terminals	Game/ Auxiliary (audio signal): 500 mV/ 47 k ohms Game/Video: 1Vp-p

■ CD player

Type	5-disc multi-play compact disc player
Signal readout	Non-contact, 3-beam semiconductor laser pickup
D/A converter	1-bit D/A converter
Frequency response	20 - 20,000 Hz
Dynamic range	90 dB (1 kHz)

■ Tuner

Frequency range	FM: 87.5 - 108.0 MHz AM: 522 - 1,620 kHz
------------------------	---

■ Cassette deck

Frequency response	50 - 14,000 Hz (normal tape)
Signal/noise ratio	55 dB (TAPE 1, playback) 50 dB (TAPE 2, recording/playback)
Wow and flutter	0.3 % (WRMS)

■ Speaker

Type	2-way type speaker system with passive radiator 5 cm (2") tweeter 13 cm (5-1/8") woofer 10 cm (4") passive radiator
Maximum input power	240 W
Rated input power	120 W
Impedance	6 ohms
Dimensions	Width: 252 mm (9-7/8") Height: 330 mm (13") Depth: 249 mm (9-13/16")
Weight	3.6 kg (7.9 lbs./each)

SHARP

WARRANTY

Consumer Electronic Products

Congratulations on Your Purchase!

This Sharp product is warranted against faults in materials and manufacture for a period of twelve (12) months from the date of original purchase.

If service is required during the warranty period, please contact your nearest Sharp Approved Service Centre. These repairs would be carried out at no charge to the owner, subject to the conditions specified herein.

The owner is responsible for any transportation and insurance costs if the product has to be returned for repair.

This warranty does not extend to accessories, defects or injuries caused by or resulting from causes not attributable to faulty parts or the manufacture of the product, including but not limited to, defect or injury caused by or resulting from misuse, abuse, neglect, accidental damage, improper voltage, liquid spillage, vermin infestation, software, or any alterations made to the product which are not authorised by Sharp.

Please retain your sales documentation, as this should be produced to validate a warranty claim.

This warranty is in addition to and in no way limits, varies or excludes any express and implied rights and remedies under any relevant legislation in the country of sale.

SHARP

IMPORTANT DO NOT RETURN THIS PAGE TO SHARP

For your reference, please enter the particulars of your purchase below and retain, with your purchase documentation.

Model No. _____

Serial No. _____

Date of Purchase _____

Retailer _____

FOR LOCATION ENQUIRIES WITHIN
AUSTRALIA

REGARDING YOUR
LOCAL

SHARP APPROVED SERVICE CENTRE

VISIT OUR WEBSITE AT

www.sharp.net.au

OR CALL SHARP

LOCAL CALL 1 300 135 022

SHARP CORPORATION OF AUSTRALIA PTY. LIMITED
A.B.N. 40 003 039 405
1 Huntingwood Drive Blacktown NSW 2148

FOR PRODUCTS PURCHASED IN
NEW ZEALAND

CONTACT YOUR SELLING DEALER/RETAILER
OR CALL

SHARP CUSTOMER SERVICES

TELEPHONE: 09 - 573 0111

FACSIMILE: 09 - 573 0113

WEB: www.sharpnz.co.nz

SHARP CORPORATION OF NEW ZEALAND LIMITED
59 Hugo Johnston Drive, Penrose Auckland

IMPORTANT NOTICE: This warranty applies only to products sold in Australia & New Zealand

SHARP

SHARP CORPORATION

TINSZA040AWZZ
04D R HK ③